

Earth bonding solutions for buildings

LPINZ has wide range of Rebarcon earthing solutions which provide the effective and reliable earth bonding of the foundation reinforcing steel to the installations electrical earthing systems. The LPINZ system is flexible and customisable to the different requirements of the installation to make the site installation much easier.

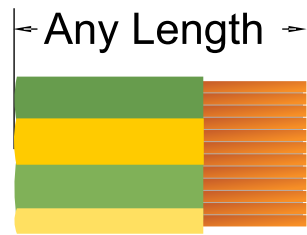
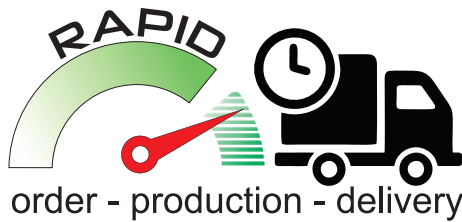
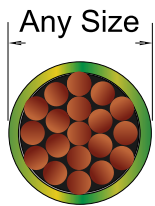

Exothermically welded connections throughout the Rebarcon ensures the very highest quality of low resistance electrical joints

Installation details

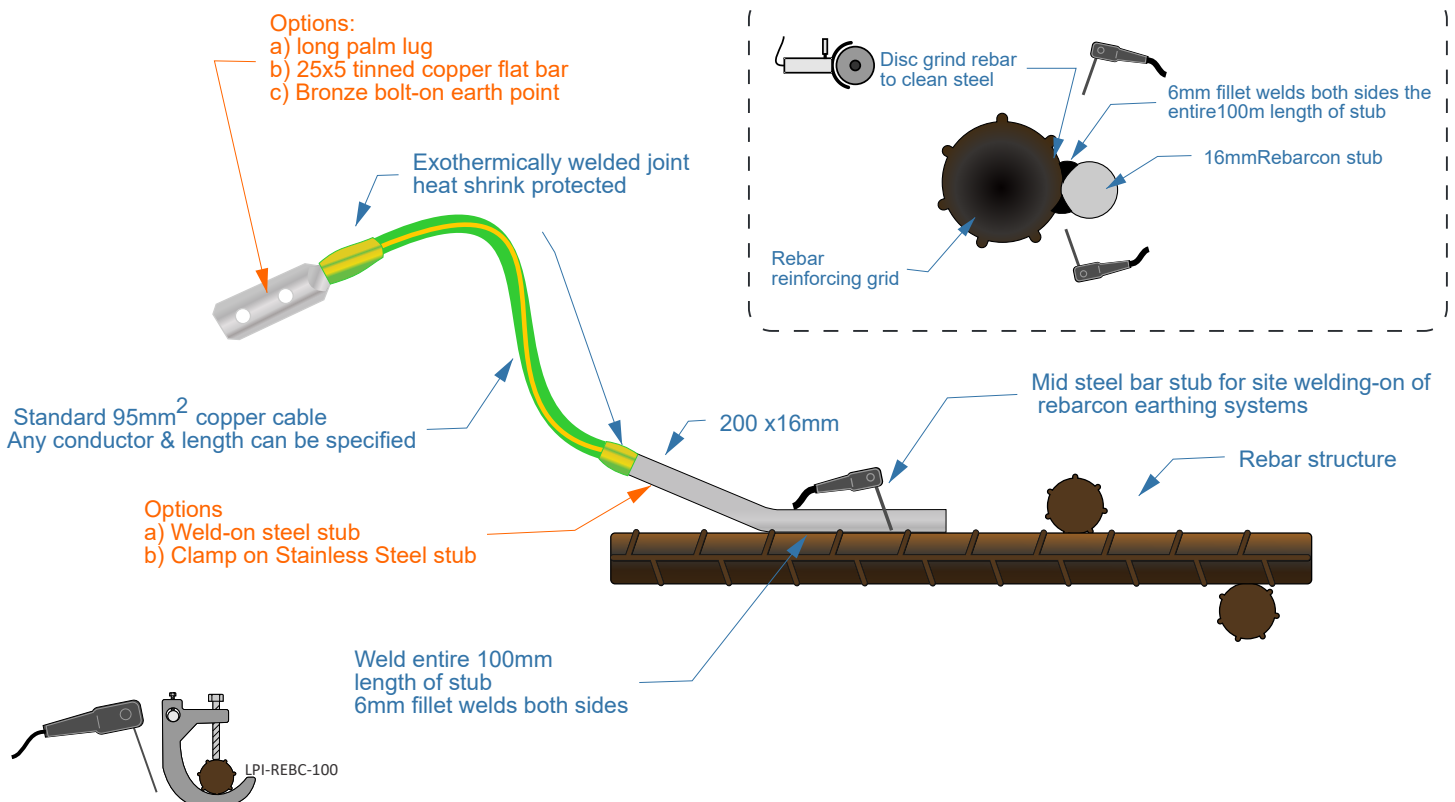

Visit our website www.lpinz.co.nz for Rebarcon order details

Earth bonding solutions for buildings

Product & Installation details

LPINZ Rebarcon's come in a standard 95m² copper conductor, 1 mtr length or can be made to any specified length.

Optional conductor size options:

50mm² 70mm² 95mm² 120mm² 185mm² 240mm²

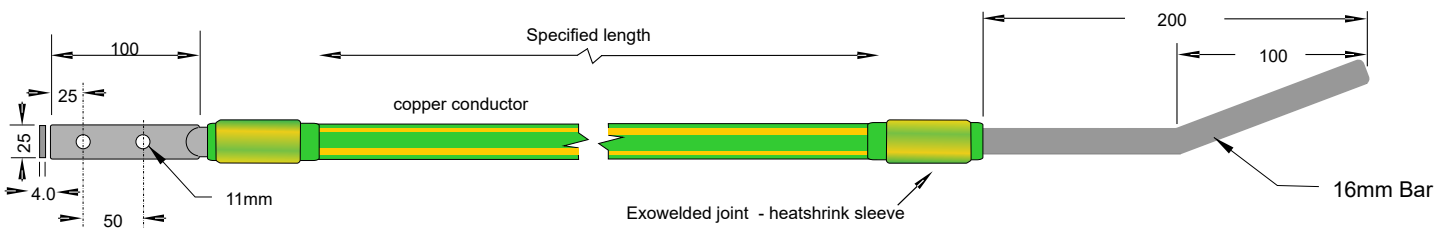

Note: lug dimension change with conductors > 95mm²

LPI-LP951M - LPINZ-REBARCON 95mm², 1m length C/W 2 hole 100 mm long lug S/S Bolts, Nuts, Washers

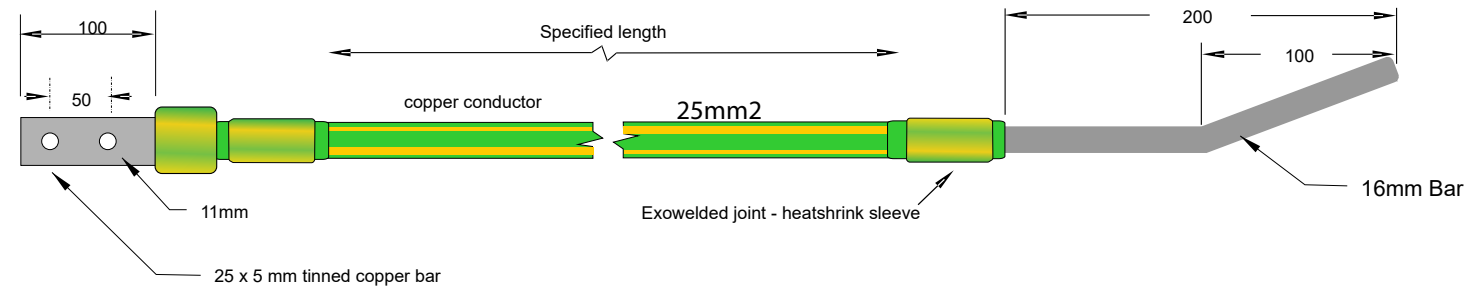

LPI-TC951M - LPINZ-REBARCON 95mm², 1m length C/W 2 hole Tinned Copper bar, SS Bolts, Nuts, Washers

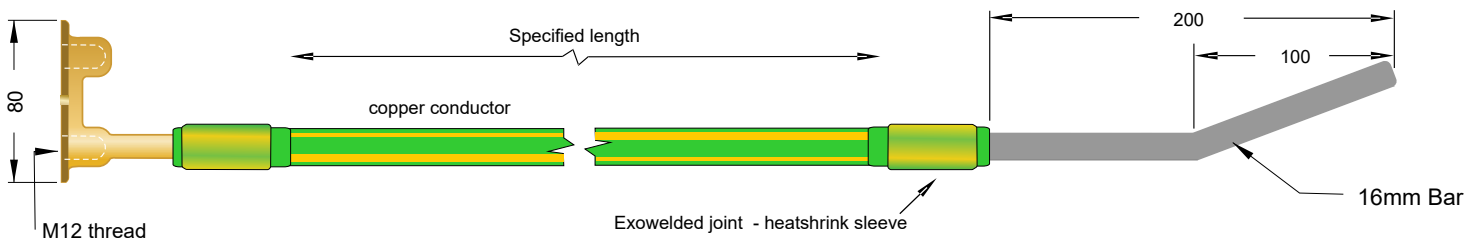

LPI-PL953M - LPI-REBARCON 95mm², 3m length C/W PLATE

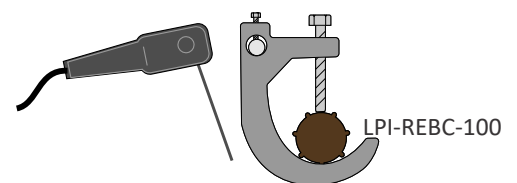
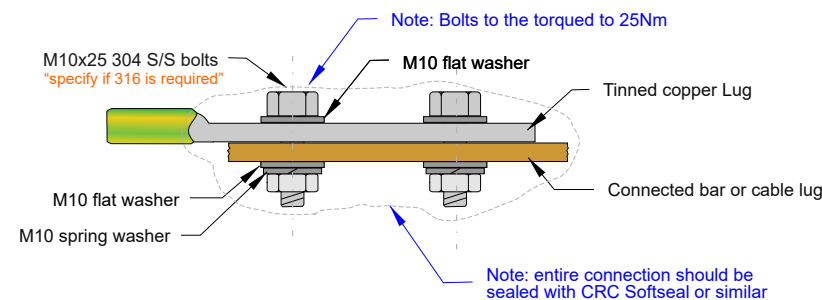

Rebarcons can be specified with:
 a) Weld on steel stub
 b) Stainless steel stub and clamp