

LIGHTNING PROTECTION INTERNATIONAL PTY LTD



CONVENTIONAL LIGHTNING PROTECTION SYSTEM



Compliance with
AS 1768,
IEC 62305,
NFPA 780 and
UL 96 Standards



Contents

The LPI Story	Page 3
Introduction	Page 4
FAQ	Page 4
In-House Design Services	Page 5
Typical Application Diagram	Page 6-7

DIRECT STRIKE COMPONENTS

Air Terminals	Page 8
Air Terminal Bases	Page 8
Conductor Fixings	Page 9
Conductor Connectors	Page 9
Conductors	Page 10
Accessories	Page 10

EARTHING & BONDING COMPONENTS

Earth Rods, Couplers and Clamps	Page 11
Earth Enhancing Compounds	Page 12
Earth Points	Page 12
Inspection Pits	Page 12
Equipotential Bonding	Page 12
Additional LPI Literature	Page 13



The LPI story

Lightning Protection International Pty Ltd (LPI) is a fully Australian owned designer, manufacturer and supplier of direct strike lightning protection, surge and transient protection, and earthing / grounding solutions.

LPI has provided specialist lightning protection advice to customers for many years in some of the most lightning-prone areas of the world. LPI personnel have extensive experience in risk management, system design, training, installation, certification, and commissioning of lightning protection systems in a wide variety of industry groups.

LPI maintains a third party Quality Management System to AS/NZS ISO 9001:2015.

LPI's range of products and services are exported from its head office and research facility (in Tasmania, Australia) and via regional offices worldwide.

LPI's Technical Capabilities

LPI's staff have been providing specialist lightning protection advice to customers worldwide, especially in the most lightning prone areas of the world. Using LPI's four-step approach to lightning protection, our engineers and consultants work together with clients and contractors to conduct site surveys, risk assessments and system designs in all industry sectors. Clients are provided with cost-effective and reliable recommendations for minimising the risks posed by lightning.

LPI has always maintained a strong commitment to research and development in order to better understand the lightning process and to be a world leader in innovative products for the lightning protection market.

The company has been recognised within Australia for its outstanding export successes and has been awarded several prestigious export awards.

LPI's 4-Step Approach to Lightning Protection

It is the strategic aim of our company to be able to provide a complete packaged solution. LPI has identified 4 key steps when considering the complete approach to lightning protection.

Our comprehensive approach to lightning protection includes:

- 1** Definition and provision of area protection
- 2** Creation of a bonded earthing system
- 3** Protection of mains power lines
- 4** Protection of signal, data and communication lines

Active in Industry



This commitment has led to significant enhancements in the design and manufacture of all our products.

LPI's Australian-based manufacturing facility has a comprehensive test laboratory equipped with a high impulse current generator for testing manufactured products in compliance with international standards. LPI has conducted extensive high voltage testing of products in independently accredited laboratories in Australia and overseas, as well as engaging in collaborations with Australian-based universities to pursue product testing and field trials.



Introduction to Conventional Protection

Direct-strike lightning protection systems (LPS) can be divided into two broad categorisations, namely “conventional” and “non-conventional”. LPI engages in the R&D, design, manufacture and sale of both types of systems in order to ensure that customers can receive the type of system they desire and also that the right system can be recommended for the customer’s particular application and circumstances.

Conventional LPS can be divided into two categories, namely “traditional” and “modern”. A traditional system uses components that require screwing and bolting onto the structure that it is protecting. A modern system allows “non-roof-penetrating” (NRP) installation via specially-designed components and the application of a strong structural adhesive.

Commensurate with its desire to provide the highest level of customer service and satisfaction, LPI is pleased to launch its new range of NRP conventional lightning protection products. It has partnered with ECLE, a high-quality component manufacturer from the USA, for completing the NRP range. All products have been engineered to maximise versatility and appearance without compromising mechanical strength or electrical performance when handling lightning strikes.

LPI’s new range of conventional lightning protection products have the following features and advantages:

- All components and systems comply with AS 1768, IEC 62305, IEC 62561, NFPA 780 and UL96
- UL-approved smooth weave conductor that is flexible enough to route around all structural features, significantly reducing the number of components required

- NRP design avoids potential water ingress into structures over time
- Quality materials with excellent corrosion resistance
- Overall, the NRP and smooth weave conductor system design lower the cost of installations by 50-70%

FAQ

1. Why should I use a woven conductor?

LPI’s smooth weave conductor (available in aluminium and tinned copper) is extremely flexible, does not kink and is easy to handle. It makes installation of the conventional LPS much easier.

2. What sort of lightning rod should I use – sharp or blunt ?

There is no simple or single answer to this question, other than to say that it depends on the structure height and location of the rod. Nevertheless, LPI is a pioneer in the area of corona-minimising air terminals, where a blunt tip is favoured over a sharp one in order to avoid the space charge effects that can make interception of lightning strikes unreliable. LPI can provide advice on the correct tip geometry for your structure based on in-house software tools, the computations behind which have been published in an international journal paper. Contact LPI for further details.

3. Why should I use aluminium components ?

Aluminium is a very common air termination material and, as such, is included in all major lightning protection standards, including IEC 62305 and AS 1768. Aside from standards compliance, LPI’s lightweight, high-strength, aluminium components are safer to manage when installing at height, corrosion resistant, more cost effective than copper and have lower freight costs.



In-house Design Services

LPI offers an in-house design service producing customised direct-strike lightning protection designs.

LPI's software utilises an AutoCAD plugin which quickly analyses 3D solid models. This software capability allows LPI to confirm that a direct strike lightning protection design is fully compliant with the selected standard, and is able to clearly highlight any areas of a structure which may not be protected under that standard.

This software allows LPI to offer a

- Full risk assessment in accordance with the relevant standard
- Customised design for each project
- Accurate, efficient and cost-effective design
- Rolling sphere design compliant with AS 1768, IEC 62305, and NFPA 780.
- PDF output including a 3D view of the site, bill of materials and generic specifications

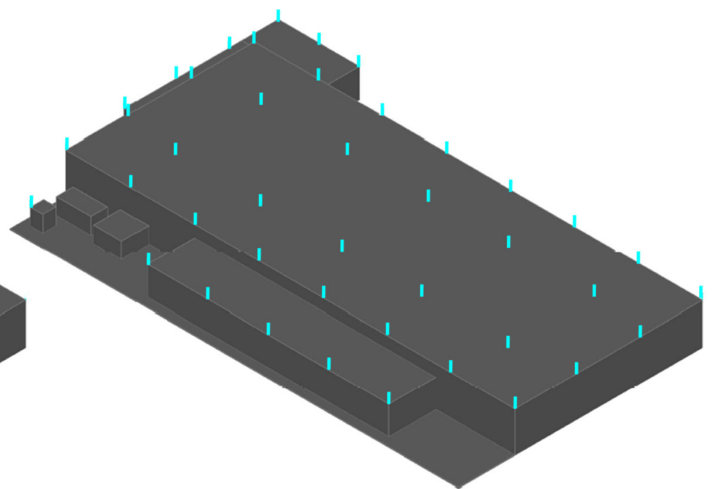
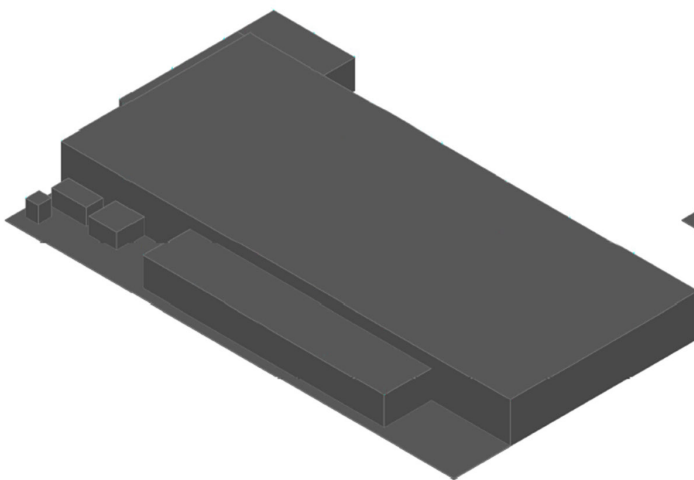
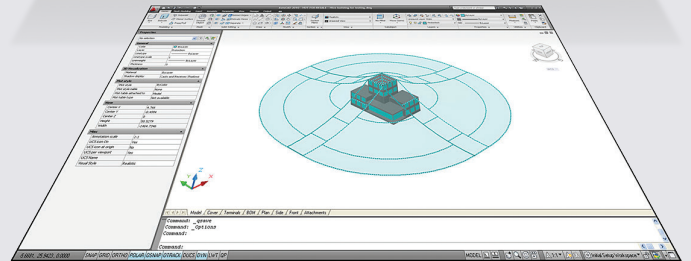
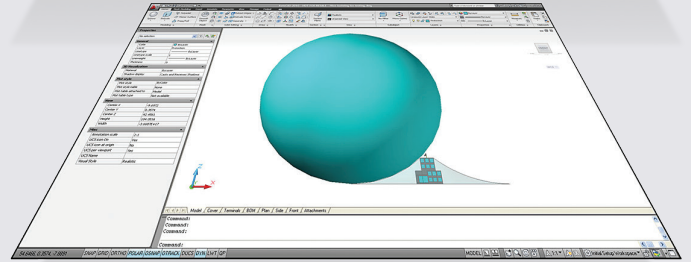
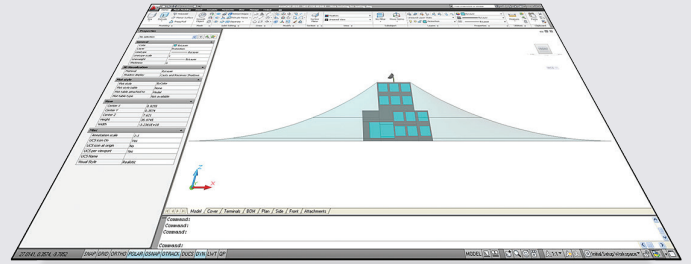

1 - Air Terminals



Refer to Page 8.

2 - Air Terminal Bases

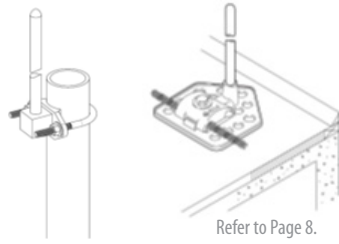

Refer to Page 8.

3 - Conductor Fixings

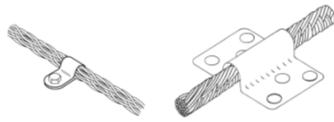

Refer to Page 9.

Accessories



Refer to Page 10.

7 - Earthing and Bonding Components



Earthing



Refer to Page 11.

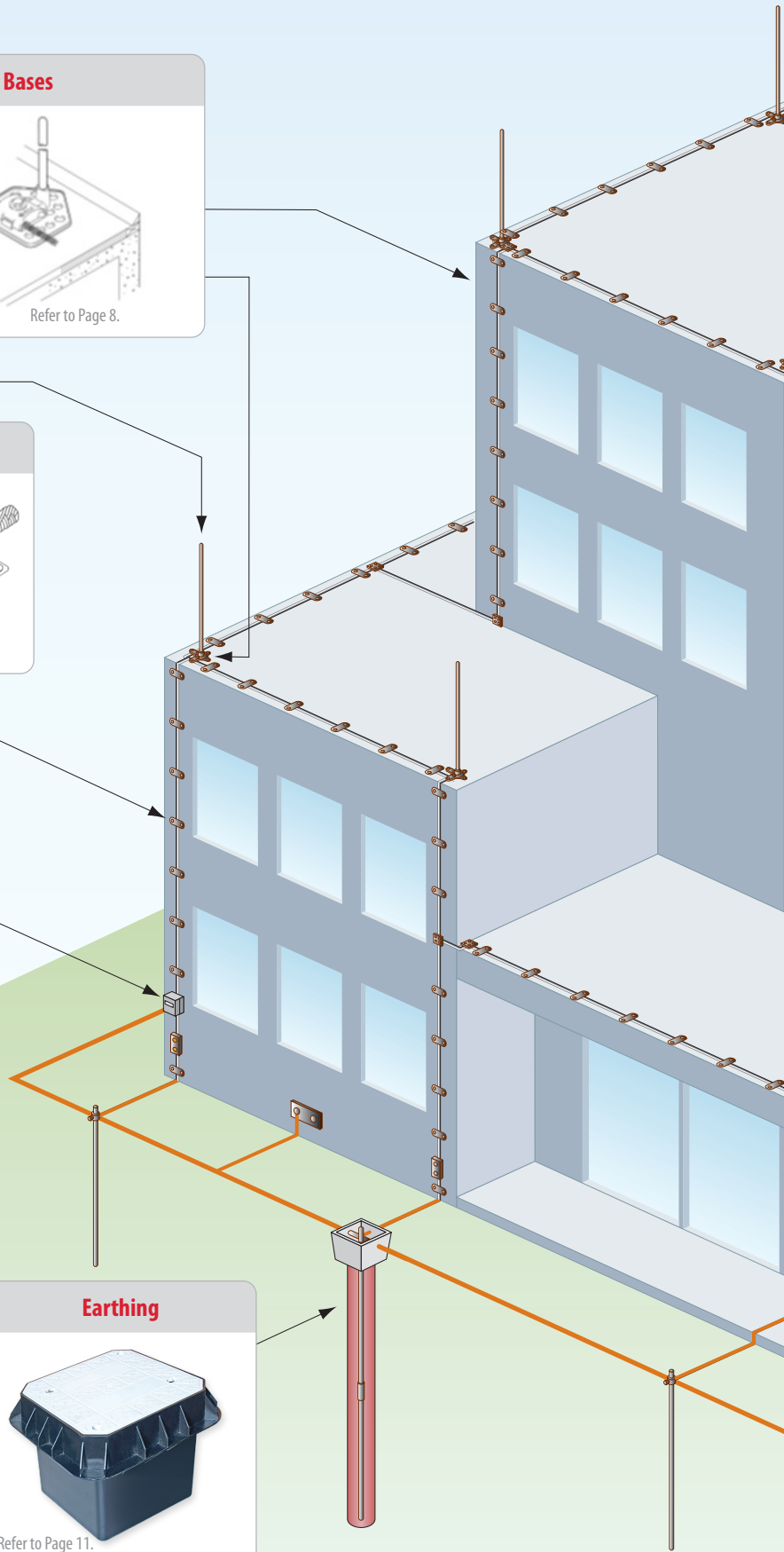

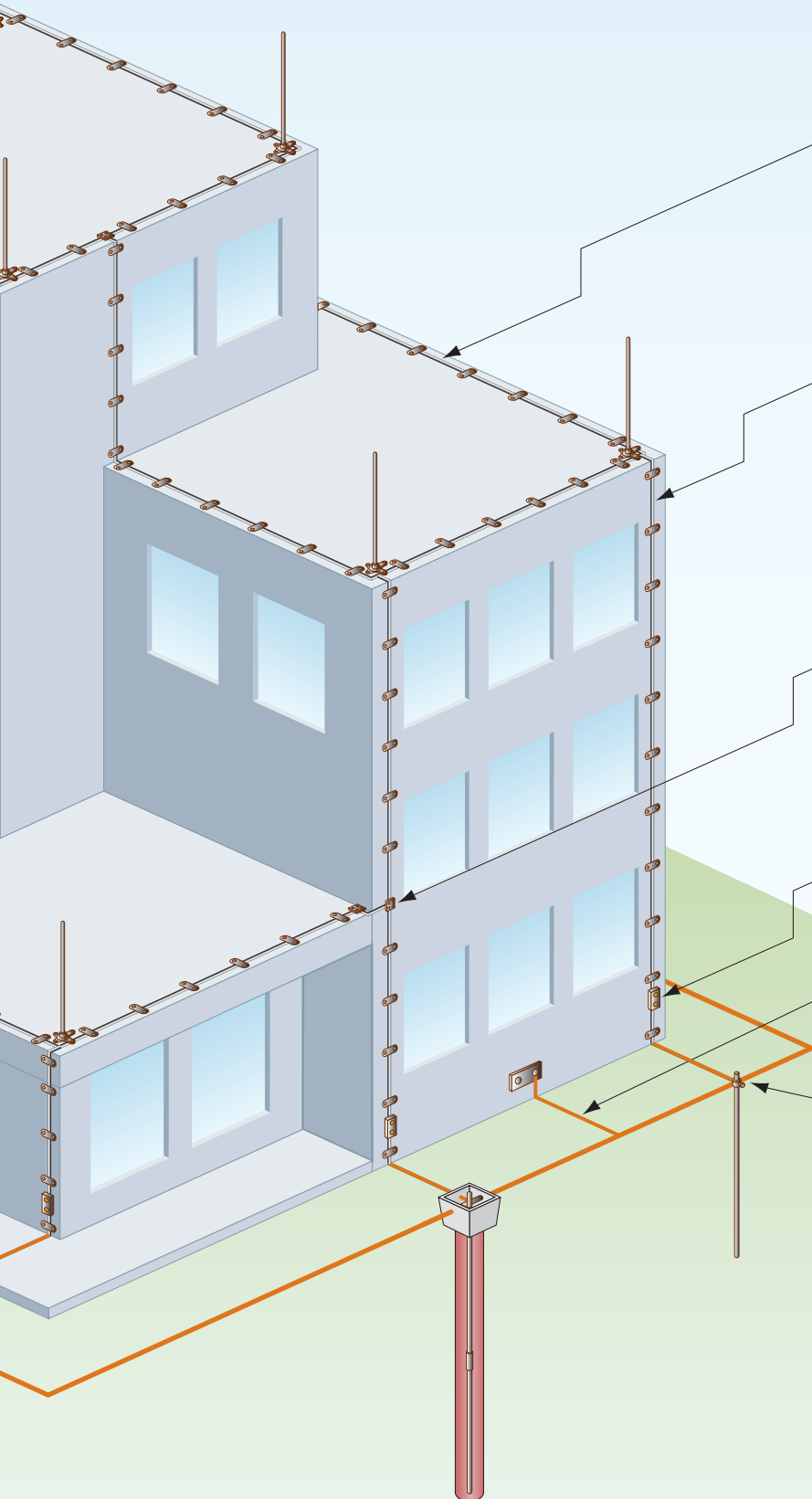

5 - Conductor



Refer to Page 10.

6 - Accessories



Refer to Page 10.

4 - Conductor Connectors

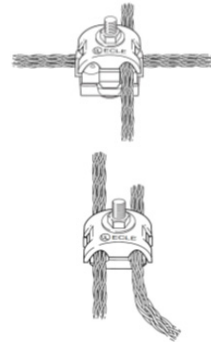

Refer to Page 9.

7 - Earthing and Bonding Components



Refer to Page 11.

7 - Earthing and Bonding Components



Refer to Page 12.

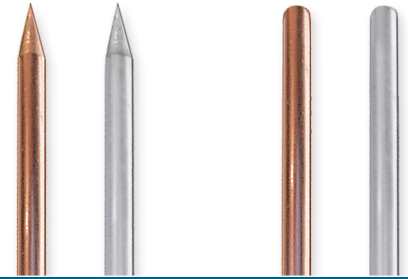

1. Air Terminals

Length (mm)	Nominal Diameter (mm)	Tip	Material	Weight (Kg)	Thread	Pack Qty.	Product Code	Description
500	14	Pointed	Copper	0.69	5/8"	1	FL1ATP0558C	Air terminal, pointed, 500 mm x 14 mm, copper, 5/8" Thread
1000	14	Pointed	Copper	1.37	5/8"	1	FL1ATP1058C	Air terminal, pointed, 1000 mm x 14 mm, copper, 5/8" Thread
500	15	Pointed	Aluminium	0.21	5/8"	1	FL1ATP0558A	Air terminal, pointed, 500 mm x 15 mm, aluminium, 5/8" Thread
1000	15	Pointed	Aluminium	0.42	5/8"	1	FL1ATP1058A	Air terminal, pointed, 1000 mm x 15 mm, aluminium, 5/8" Thread
500	14	Blunt	Copper	0.69	5/8"	1	FL1ATB0558C	Air terminal, blunt, 500 mm x 14 mm, copper, 5/8" Thread
1000	14	Blunt	Copper	1.37	5/8"	1	FL1ATB1058C	Air terminal, blunt, 1000 mm x 14 mm, copper, 5/8" Thread
500	15	Blunt	Aluminium	0.21	5/8"	1	FL1ATB0558A	Air terminal, blunt, 500 mm x 15 mm, aluminium, 5/8" Thread
1000	15	Blunt	Aluminium	0.42	5/8"	1	FL1ATB1058A	Air terminal, blunt, 1000 mm x 15 mm, aluminium, 5/8" Thread

NOTES: Custom lengths available upon request

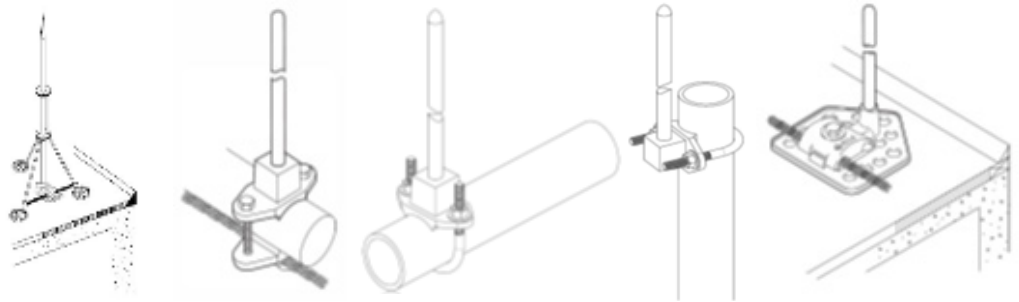

2. Air Terminals Bases

Suits	Material	Weight (g)	Pack Qty.	Product Code	Description
5/8" Threaded copper finial & tinned copper 35 mm ² woven conductor	Bronze	454	5	BB3B5/8	2 Way Cast bronze adhesive base to suit 5/8" copper finial
5/8" Threaded aluminium finial & aluminium 50 mm ² woven conductor	Aluminium	170	5	BB3A5/8	2 Way aluminium adhesive base to suit 5/8" aluminium finial
5/8" Threaded copper finial	Bronze	498	5	BB26B5/8	Horizontal pipe top mount, cast bronze base to suit 5/8" copper finial where no conductor is required
5/8" Threaded aluminium finial	Aluminium	212	5	BB26A5/8	Horizontal pipe top mount, aluminium base to suit 5/8" aluminium finial where no conductor is required
5/8" Threaded copper finial	Bronze	498	5	BB28B5/8	Vertical pipe mount, cast bronze base to suit 5/8" copper finial where no conductor is required
5/8" Threaded aluminium finial	Aluminium	212	5	BB28A5/8	Vertical pipe mount, aluminium base to suit 5/8" aluminium finial where no conductor is required
5/8" Threaded copper finial & tinned copper 35 mm ² woven conductor	Bronze	312	5	BB14B5/8	Horizontal pipe mount, cast bronze base to suit 5/8" copper finial where conductor is used
5/8" Threaded aluminium finial & aluminium 50 mm ² woven conductor	Aluminium	99	5	BB14A5/8	Horizontal pipe mount, aluminium base to suit 5/8" aluminium finial where conductor is used
5/8" Threaded copper finial & tinned copper 35 mm ² woven conductor	Galvanized steel bronze	703	1	TB36B	Terminal tripod braces with bronze feet for adhesive applications, overall height 91 cm
5/8" Threaded aluminium finial & aluminium 50 mm ² woven conductor	Galvanized steel aluminium	935	1	TB36A	Terminal tripod braces with aluminium feet for adhesive applications, overall height 91 cm

Notes: All fastening hardware is 316 stainless steel

Note: Other options available upon request

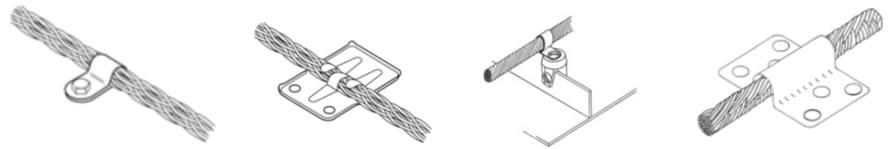

3. Conductor Fixings

Suits	Material	Weight (g)	Pack Qty.	Product Code	Description
Tinned copper 35 mm ² smooth weave conductor	Copper	31	25	FL6C	Layover adhesive stamped copper cable holder
Aluminium 50 mm ² smooth weave conductor	Aluminium	14	25	FL6A	Layover adhesive stamped aluminium cable holder
Tinned copper 35 mm ² smooth weave conductor	Copper	40	25	FL4C	Stamped adhesive crimp copper loop for use on built-up, single membrane or other flat surfaces where mechanical penetrations must be avoided
Aluminium 50 mm ² smooth weave conductor	Aluminium	23	25	FL4A	Stamped adhesive crimp aluminium loop for use on built-up, single membrane or other flat surfaces where mechanical penetrations must be avoided
Tinned copper 35 mm ² smooth weave conductor	Copper	4	25	FL1C	1 Nail stamped copper loop
Aluminium 50 mm ² smooth weave conductor	Aluminium	3	25	FL1A	1 Nail stamped aluminium loop
Tinned copper 35 mm ² smooth weave conductor	Bronze	94	25	FL5B	Standing seam bronze fastener with one 1/4" bolt to anchor to the standing seam and 1/4" hole on top. Supplied with 1 x FL3C loop and extra bolt for top mounting of loop
Aluminium 50 mm ² smooth weave conductor	Aluminium	34	25	FL5A	Standing seam cast aluminium fastener with one 1/4" bolt to anchor to the standing seam and 1/4" hole on top. Supplied with 1 x FL3C loop and extra bolt for top mounting of loop

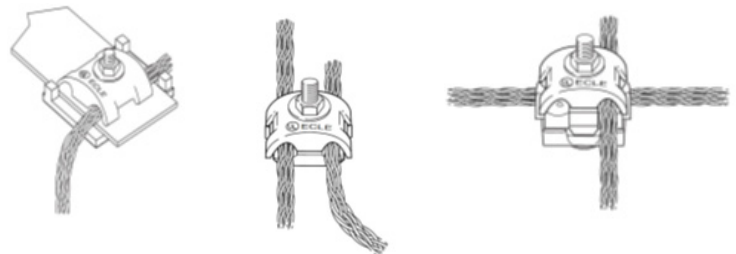

4. Conductor Connectors

Suits	Material	Weight (g)	Pack Qty.	Product Code	Description
Tinned copper 35 mm ² smooth weave conductor	Bronze	215	5	BF100B	Round - Round, cast bronze bolt cable to cable clamp, specifically designed for cable splice on single membrane roofs
Aluminium 50 mm ² smooth weave conductor	Aluminium	85	5	BF100A	Round - Round, aluminium bolt cable to cable clamp, specifically designed for cable splice on single membrane roofs
Tinned copper 35 mm ² smooth weave conductor	Bronze	227	5	BF13B	Cross run, cast bronze cross run or cross tee clamp
Aluminium 50 mm ² smooth weave conductor	Aluminium	99	5	BF13A	Cross run, aluminium cross run or cross tee clamp
Tinned copper 35 mm ² smooth weave conductor & 25 mm x 3 mm copper tape	Bronze	195	5	BF21B	Cable to strip conductor, cast bronze two way cable holder with cast flat backed bottom
Aluminium 50 mm ² smooth weave conductor & 25 mm x 3 mm aluminium tape	Aluminium	65	5	BF21A	Cable to strip conductor, aluminium two way cable holder with cast flat backed bottom

Notes: All fastening hardware is 316 stainless steel

Note: Other options available upon request

5. Conductors



Material	Weight (g) per metre	Reel Size (m)	Product Code	Description
Tinned Copper	343	500	BWCC35	Bare Tinned copper 35 mm ² smooth weave conductor
Tinned Copper	343	PER M	BWCC35-PM	Bare Tinned copper 35 mm ² smooth weave conductor PER M
Aluminium	172	500	BWAC50	Bare Aluminium 50 mm ² smooth weave conductor
Aluminium	172	PER M	BWAC50-PM	Bare Aluminium 50 mm ² smooth weave conductor PER M
Aluminium	198	50	FL6T253A	Soft Drawn aluminium tape, 25 mm x 3 mm

Notes: Aluminium tape sold as 50m length only.



Tinned Flexible Connector

Length	Material	Weight (gram)	Hole Size	Product Code	Description
200 mm	Tinned copper braid	90	Ø13 mm	FL5TFC200C	Tinned flexible connector, 25 x 3.5, 200 mm long
300 mm	Tinned copper braid	120	Ø13 mm	FL5TFC300C	Tinned flexible connector, 25 x 3.5, 300 mm long
400 mm	Tinned copper braid	150	Ø13 mm	FL5TFC400C	Tinned flexible connector, 25 x 3.5, 400 mm long



6. Accessories

Suits	Material	Weight (Kg)	Pack Qty.	Product Code	Description
Aluminium and copper smooth weave conductors	Copper / Aluminium	0.17	5	BM3	Bimetallic 4-Bolt straight splicer for joining aluminium and copper cables complete with stainless steel bolts
Accessories for adhesive fixing	Sealant	6.86	24	M1-24	Heavy duty adhesive sealant, 300ml, 24 tubes per box
Accessories for adhesive fixing	Sealant	0.28	1	M1	Heavy duty adhesive sealant, 300ml, per tube
Tinned Copper 35 mm ² woven and Aluminium 50 mm ² woven conductor	Polycarbonate	0.56	1	LSR2	Lightning strike recorder

7. Earthing & Bonding Components



Earth Rods

Nominal Length (m)	Nominal Diameter (mm)	Thread Diameter	Material	Electrolytical	Weight (kg)	Product Code	Description
1.2	14	5/8" UNC	High tensile low carbon steel	99.9 % pure copper, 254 µm	1.54	CBER1214	Copper bonded earth rod, 1.2 m x 14 mm, 5/8" Threaded both ends, 254 µm
1.2	17	3/4" UNC	High tensile low carbon steel	99.9 % pure copper, 254 µm	1.92	CBER1217	Copper bonded earth rod, 1.2 m x 17 mm, 3/4" Threaded both ends, 254 µm



Earth Rod Couplers

Suits	Thread	Material	Weight (gram)	Product Code	Description
14 mm Rods	5/8" UNC	High strength copper alloy	130	LEH-58R	Coupling for threaded rod, 14 mm, 5/8" Thread
17 mm Rods	3/4" UNC	High strength copper alloy	130	LEH-34R	Coupling for threaded rod, 17 mm, 3/4" Thread



Earth Rod Clamps

Suits	Material	Weight (gram)	Product Code	Description
14 mm Rods – 17 mm Rods	Cable 35 mm ² - 120 mm ²	90	RCC35120	Rod to cable clamp, 14-17 mm rods, 35 – 120 mm ² cable
14 mm Rods – 17 mm Rods	Tape 25 x 3 mm	90	RTC253	Rod to tape clamp, 25 x 3 mm tape

All rod clamps supplied with 316 stainless steel fasteners



Earth Enhancing Compounds

Weight (kg)	Product Code	Description
20	RESLO-20	Bentonite-based resistance lowering compound
20	SRIMPLUS-20	Carbon based resistance lowering material

All compounds comply with AS 2239 and are designed to comply with IEC 62561-7



Earth Points

No of Holes	Thread	Hole Spacing	Mass (gmm)	Stem Diameter (mm)	Material	Product Code	Description
2	M12, (18 mm deep)	45 mm	190	10.5 mm	UNS-C38000 (high strength copper alloy)	EP2M12	Earth Point, 2 x M12

Also available in single hole and four hole configurations

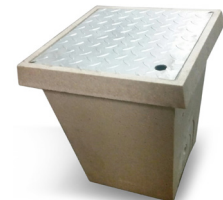

Inspection Pits

Material	Class Rating	Mass (kg)	Dimensions (mm)	Product Code	Description
Polymer	C	1.9	293 x 293 (outside), 176 x 176 (inside), 210 (deep), Ø69 Access Hole	EPIT-P	Polymer Earth Pit
Polycrrete	D	22.1	385 x 385 (outside), 260 (deep)	EPIT-C1D	Polymer concrete pit + Gal lid



Equipotential Bonding

Rated DC sparkover voltage	Impulse spark-over voltage	Max. Discharge current (I _{max})	Insulation resistance	Operating Temp. (°c)	Environ-ment Rating	Dims.	Mounting	Weight	Product Code	Description
600 V (1kV/μs)	<1.5 kV (1kV/μs)	200 kA 8/20 μs	> 1 G Ohms (at 100 Vdc)	-40° to +90°	IP 66	600 mm (L) x Ø40 mm	2 x 300 mm flying lead with M10 Crimp lug	320 g	TEC100-2L	Transient Earth Clamp, 600 V, 200 kA 8/20 μs

Together with the products and systems shown in this catalogue, a number of LPI publications are available for download from our website (www.lpi.com.au) that cover the entire range of Lightning Protection and Surge and Transient Protection products and systems. If you would like further information on any of these products, please contact LPI, or your nearest LPI Distributor, or visit: www.lpi.com.au

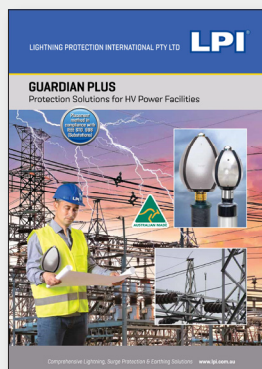
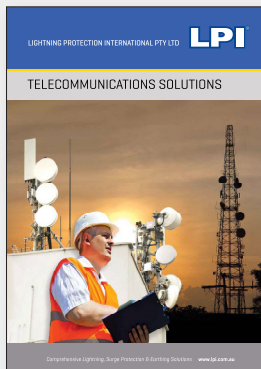
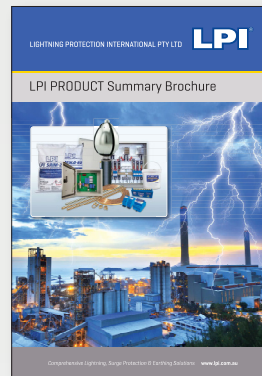
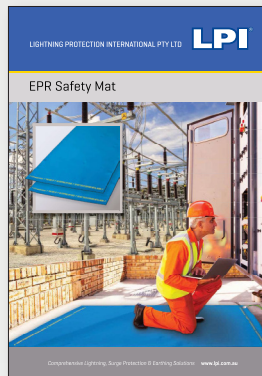
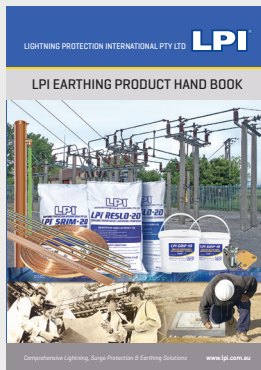
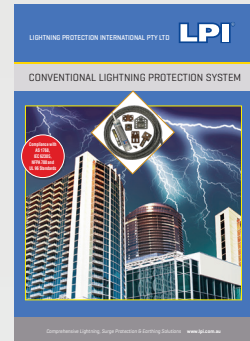
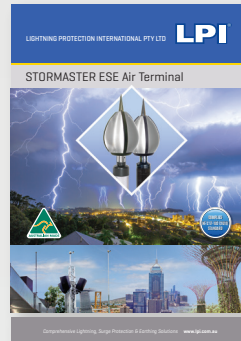

Disclaimer

- LPI maintains a policy of on-going product development, specifications are subject to change without notice.
- Application detail, illustrations and schematic drawings are representative only and should be used as guides.
- It should be noted that 100% (100 percent) protection level for direct strike lightning, lightning detection and surge and transient protection equipment is not possible and cannot be provided due to the lightning discharge process being a natural atmospheric event.

Distributed by:

LIGHTNING PROTECTION INTERNATIONAL PTY LTD

ABN 11 099 190 897



PO Box 379 Kingston, Tasmania, Australia 7051
49 Patriarch Drive, Huntingfield, Tasmania, Australia 7055

- Telephone: *Australia:* 03 6281 2477
International: +61 3 6281 2480
- Email: info@lpi.com.au
- Web: www.lpi.com.au