

# Earth bonding solutions for buildings

LPINZ has wide range of Rebarcon earthing solutions which provide the effective and reliable earth bonding of the foundation reinforcing steel to the installations electrical earthing systems. The LPINZ system is flexible and customisable to the different requirements of the installation to make the site installation much easier.

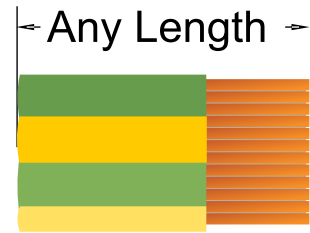
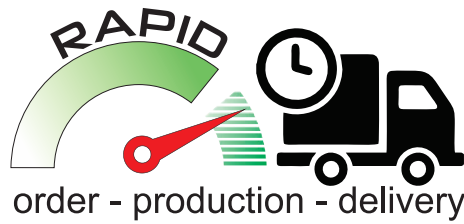
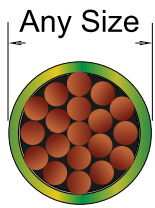

Exothermically welded connections throughout the Rebarcon ensures the very highest quality of low resistance electrical joints

## Installation details

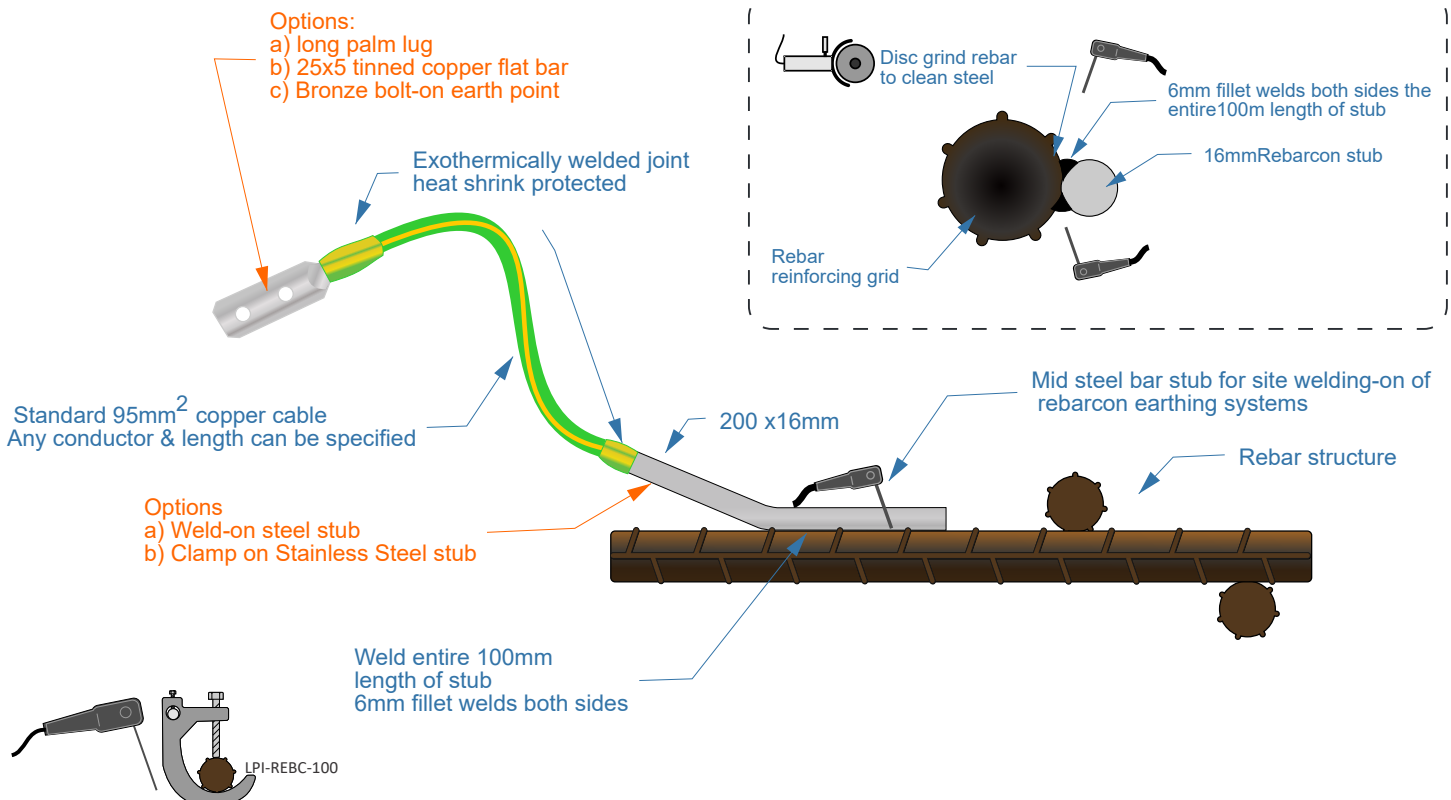

Visit our website [www.lpinz.co.nz](http://www.lpinz.co.nz) for Rebarcon order details

# Earth bonding solutions for buildings

## Product & Installation details

LPINZ Rebarcon's come in a standard 95m<sup>2</sup> copper conductor, 1 mtr length or can be made to any specified length.

Optional conductor size options:

50mm<sup>2</sup>    70mm<sup>2</sup>    95mm<sup>2</sup>    120mm<sup>2</sup>    185mm<sup>2</sup>    240mm<sup>2</sup>

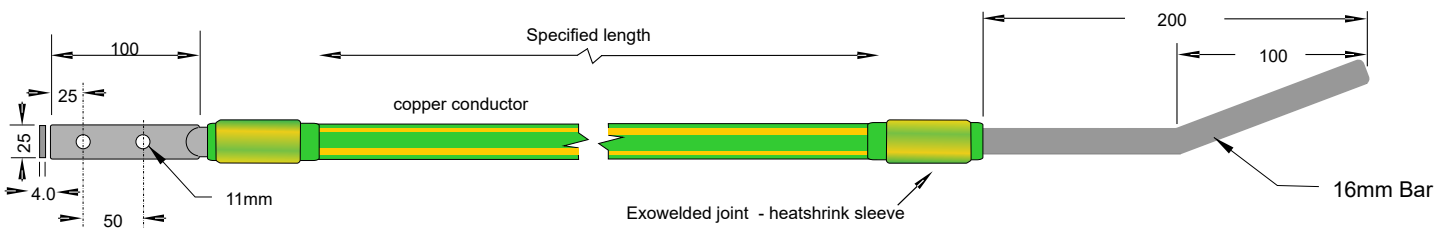

Note: lug dimension change with conductors > 95mm<sup>2</sup>

LPI-LP951M - LPINZ-REBARCON 95mm<sup>2</sup>, 1m length C/W 2 hole 100 mm long lug S/S Bolts, Nuts, Washers

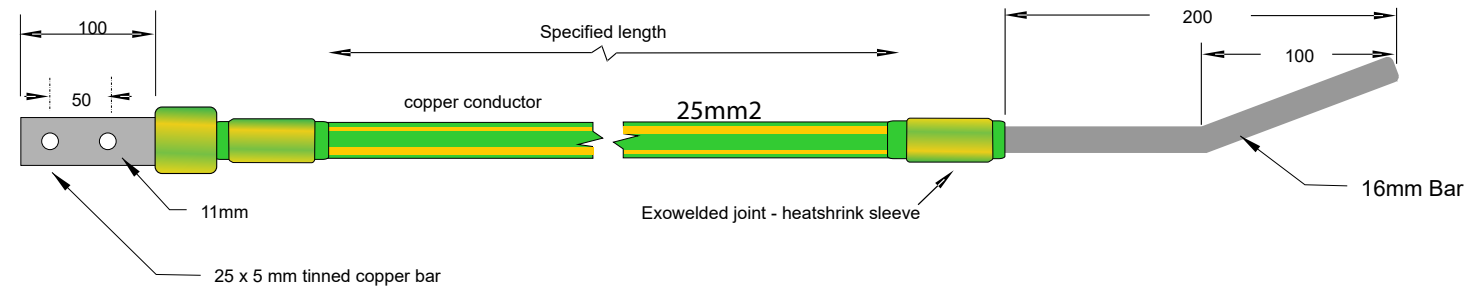

LPI-TC951M - LPINZ-REBARCON 95mm<sup>2</sup>, 1m length C/W 2 hole Tinned Copper bar, SS Bolts, Nuts, Washers

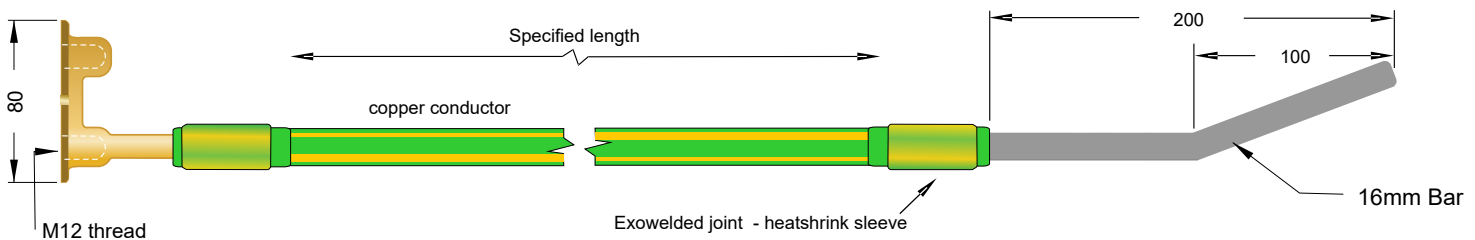

LPI-PL953M - LPI-REBARCON 95mm<sup>2</sup>, 3m length C/W PLATE

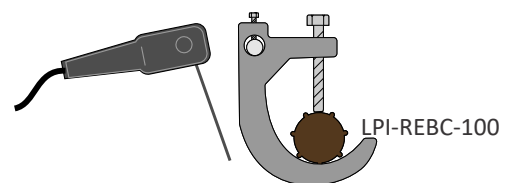
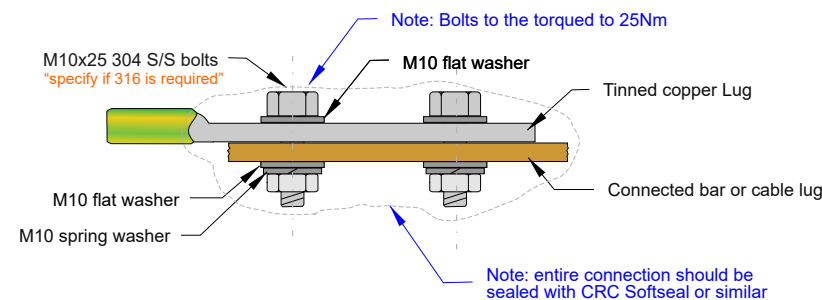

Rebarcons can be specified with:  
 a) Weld on steel stub  
 b) Stainless steel stub and clamp